



Tell: 021- 444 82 544
021- 225 15 912
Fax: 021- 444 84 736

Reg no. : 466094
www.arco-hvac.ir
www.kiatahvie.ir



KIA TAHVIE ARAD



AIR-COOLED SCREW CHILLER

چیلر های هوا خنک اسکرو

FEATURES

The TASD series air-cooled screw chiller adopts the modular design to provide cold water to air side products of central air conditioners. Selective cooling parts and control components provided by world-famous manufacturers, together with the most cutting-edge intelligent control system, contribute to the high efficiency, energy conservation, stability and reliability of this air-conditioning. The standard multi-unit control function supports the control over up to 8 units at the same time; and an optional built-in hydraulic module can be configured as required. The unit can also be connected to the building automation system (BAS) to easily meet various air-conditioning requirements in different places. The unit can be applied to various situations for comfortableness and arts and crafts, such as, hotel, hospital, office building, shopping mall, apartment, and factory.



STABLE AND RELIABLE OPERATION

- The unit compressor adopts the high-efficiency semi-hermetical twin-screw design. Therefore, it can be used without concern for refrigerant leakage, when compared to the hermetical compressor, it boasts easier maintenance and less pay for any repairs; and when compared to the single-screw compressor, it features fewer vulnerable parts, zero energy loss, and higher reliability.
- The compressor motor directly connects to the rotor with no gearbox involved, which avoids energy loss caused by gear transmission; moreover, fewer moving parts can ensure lower noise and a more reliable operation.
- The unit uses the stand-alone pass and in particular, the two stand-alone passes for twin-compressor units. In this way, the unit can guarantee reliable operations, and there is no requirement for the oil balance pipeline between units, ensuring better backup and substantially improving the unit reliability.
- The unit control system features high efficiency, reliability, and intelligence through constant optimization by engineers. All cooling parts and control components of the unit are provided by world-famous reliable suppliers to make the unit compact, highly efficient, energy saving, and reliable.
- The performance, reliability and structure of the unit are verified and optimized by the long-term simulation tests under various changing conditions and extreme conditions, as well as transportation experiment on actual tertiary roads.



MODULAR DESIGN

- The unit adopts the modular design. Each microcomputer controller of the unit reserves the interface for connecting the combined control module. Networking control between units can be implemented by cable connection and simple master-slave settings. A maximum of 8 main units can be controlled in a combined manner, which means that the unit capacity can be easily expanded to meet various air-conditioning requirements in different places.
- The main unit can be used to manage all modules in a centralized manner, select the number of modules, and monitor the operating data and status.
- Modules are independent of each other. A single failure of a module in a unit does not affect the operation of the other modules.
- The unit is provided with standard RS485 interface and supports the MODBUS-RTU protocol. It can implement centralized control and remote monitoring of the unit, and regulate other chiller auxiliaries as required by the BAS.

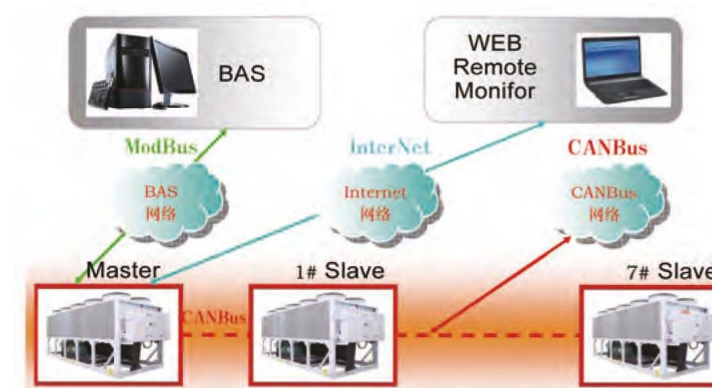

CONVENIENT INSTALLATION

- The unit can be directly installed outdoors without the cooling tower. The compact structure of the unit takes small space and is cost-saving.
- The lifting lug design makes the hoisting process simple and safe.
- The water pipe of the water-side heat exchanger has been equipped with the water flow switch and is ready to use, which saves the on-site installation time.
- Inlet and outlet pipes are clamped, which makes the on-site installation easier.
- The unit comes with the startup cabinet and control cabinet and has been filled with refrigerant and refrigeration oil before delivery. Only the water pipe and power supply need to be connected upon installation on site. The unit can be put into use after the initial on-site commissioning by the after-service personnel of KTA.
- The built-in hydraulic module of the unit is optional. This module integrates all necessary hydraulic components such as the water pump, filter, expansion tank, flow switch, safety valve, pressure gauge, and drainage valve. Customers can debug the running after connecting the water pipes at ends.

THROTTLE APPARATUS

- The unit uses the world's most advanced electronic expansion valve, which ensures excellent performance both under full load or partial load and higher control accuracy.
- When compared with the thermal expansion valve, electronic expansion valve reacts more quickly when the unit is partly loaded. In addition, the evaporator can be fully used in any condition, which ensures more adequate and higher efficient heat exchange.



HIGH-EFFICIENCY COMPRESSOR

- The highly efficient semi-hermetical twin-screw compressor adopts the world-class latest generation 5:6 patented asymmetric tooth-type rotor to greatly improve the adiabatic efficiency. This type of high-efficiency motor with large capacity can significantly enhance the energy efficiency.

- The compressor motor directly connects to the rotor with no gearbox involved, which avoids energy loss caused by gear transmission; moreover, fewer moving parts can ensure lower noise and a more reliable operation.

- The high-precision filter screen built in the compressor increases the oil separation efficiency up to 99.5%.

- The unit adopts the semi-enclosed twin-screw compressor and air suction cooling motor to ensure that the motor is fully cooled.

- The compressor adopts the slide valve for adjustment. A single compressor can precisely match 25% – 100% load changes, and dual-compressor up to 12.5% – 100% load changes, which reduces operating expenditure to the greatest extent.

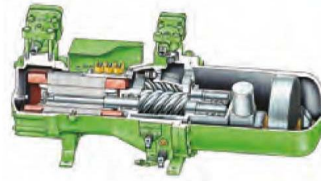

LOW-NOISE OPERATION

- The unit adopts the low-noise type outer rotor axial flow fan with long type air duct for diversion to effectively reduce the airflow noise. Before delivery, the fan has undergone strict tests for static and dynamic equilibrium to ensure stable and low-noise operation.

- The silencer built in the compressor reduces noise effectively.

- The compressor uses the precision machined rotor and the surface of the rotor is hardened by laser. The correction of static and dynamic equilibrium can minimize the vibration.

- The compressor feet are equipped with shock pads to reduce unit vibration and substantially lower the unit noise.



HIGH-EFFICIENCY HEAT EXCHANGER

- The patented counter-current water-side heat exchanger, combined with the inner-threaded efficient heat exchange pipe, can increase heat exchange efficiency by 20% to 30%.

- The wind-side heat exchanger adopts a unique process design to ensure that the refrigerant is in the best flow rate in any condition. In this way, the refrigerant pressure in the wind-side heat exchange copper pipe can be reduced to a minimum, which effectively decreases the power consumption of the compressor and improves the energy efficiency of the unit.

- The use of inverted "M" type heat exchanger reduces ventilation resistance, improves air flow velocity distribution, and increases heat exchange efficiency.

- The use of large air volume silent fan increases the air flow through the tube fins, which improves the heat exchange efficiency of the wind-side heat exchanger.

- The graded control of the unit fan effectively reduces the fan power consumption of the unit in the transitional ambient temperature.

- The use of new open-window aluminium fin greatly enhances the gas turbulence of the wind-side heat exchange tube and the surface of the fin. In this way, the heat exchange efficiency is increased by about 8%.

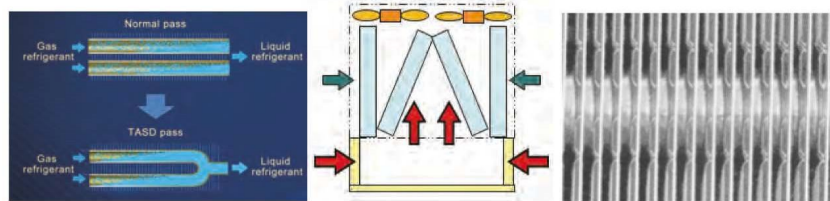

UNIT MICROCOMPUTER CONTROL CENTER

The industrial-level microcomputer controller, together with the LCD touch screen, constitutes the control unit of the unit. While KTA's unique self-control technology and up-to-edge control technology in the world create powerful control functions of our controller.

The leading intelligent control program ensures accurate management of water temperature under any condition and guarantees energy-saving, safe, and stable operation of the unit by automatic control. Meanwhile, the advanced pre-control function enables measures to be taken timely before actual failure occurs to avoid frequent shutdown of the unit.

The unit supports the compiling of weekly operating schedules to implement comprehensive automatic start and stop control of the unit, which truly implements unattended and automatic operation.



Main functions:

Local and remote automatic control

Start and stop control of the unit

Real-time display of the operating status and parameters

Display and settings of control parameters

Self-test upon unit startup

Adjustment and control of the energy

Control of the balanced operation of the compressor

Control to prevent frequent startup of the compressor

Graded energy-saving control of the fan

Water pump interlock control

Multi-unit control

Real-time displaying operation permission grading function

Automatic shutdown upon alarm and failure display function

Historical fault memory function

RS485 communication interface (communication function)

Protection functions:

Power overvoltage and under-voltage protection

Protection of power supply default phase, reverse phase, and unbalanced phase

Compressor oil level protection

Compressor motor overheat protection

Compressor motor overload protection

Compressor overload protection

Compressor start failure protection

Protection of over high condensation pressure (exhaust)

Protection of over low evaporation pressure (suction)

Protection of air suction/exhaust pressure difference

System pressure warning protection

Protection of over low cooling outlet water temperature

Water flow switch protection

Protection of over high air exhaust temperature

Communication failure protection

EVD electronic expansion valve protection

UNIT OPTIONS

- Year-round cooling unit: all-year-round cooling; lowest ambient cooling temperature of -5°C .

- Compressor noise enclosure: to reduce the compressor noise.

- Protection screen: to effectively protect the unit.

- Accessory: spring shock absorber.

- Process cooling unit: to provide customized inlet/outlet water temperature condition.

- Build-in hydraulic module: This module integrates all necessary hydraulic components such as the water pump, filter, expansion tank, flow switch, safety valve, pressure gauge, and drainage valve. Customers can debug the running after connecting the water pipes at ends.



BUILT-IN HYDRAULIC KIT (OPTIONAL)

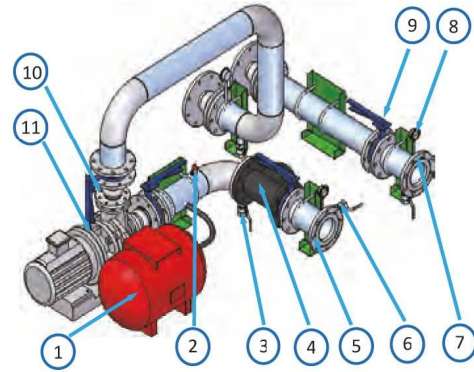

Number	Name	Number	Name
1	Expansion Tank	8	Pressure Gauge
2	Safety Valve	9	butterfly valve
3	Drain Valve	10	Soft Rubber Joint
4	Filter	11	Water Pump
5	Water Inlet		
6	Charging Valve		
7	Water Outlet		

Built-in Hydraulic kit system integrate water pump, filter, expansion tank, flow switch, safety valve, pressure gauge, drain valve, etc. It is convenient for users to connect water pipe and operate running test. Saving initial investment and make it easy to install the unit. Built-in hydraulic kit is controlled by micro computer, users can see the state of unit by screen.

RELIABLE PERFORMANCE

● **KTA** designers conduct optimal design for critical components and system pipelines of the chiller on the basis of existing theories and in combination with internationally advanced design concepts and always put the stability of the chiller in the first place.

● The chiller adopts compressor of international famous brand with high stability.

● Original control by electronic expansion valve effectively solves problems of carrying liquid, throwing oil and system oscillation, etc. during defrosting and enables stable operation of the chiller.

● Balanced design of high precision for distribution pipe of refrigerant in heat exchanger on air side of the chiller guarantees uniform distribution of refrigerant in heat exchanger on air side, enhances heating capacity and improves frosting condition.

● External oil cooler controls oil temperature of compressor and enables more stable and reliable heating operation of the chiller at low temperature.

● Long-term simulation tests: including tests for various variable working conditions, extreme working conditions, defrosting of heat pump and practical tertiary highway transportation, etc. to verify and optimize performance, reliability and structure of the chiller.



PRODUCT NOMENCLATURE

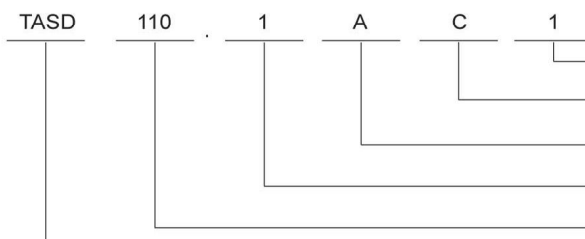

Refrigerant: 1-R134a
 Series codes: C- cooling only
 Design codes: A, B, C...
 Number of compressors: 1, 2, 3
 Specification codes: 110, 145...

SPECIFICATIONS

KTATASD-AC1(R134a) Air-cooled Screw Chiller - Cooling Only

Unit Model TASD-AC1		110.1	145.1	170.1	210.1	230.2	260.2	285.2	345.2	405.2	
Nominal Cooling Capacity	kW	385	505	601	730	808	909	1001	1210	1425	
	kcal/h	331100	434300	516860	627800	694880	781740	860860	1040600	1225500	
Cooling Rated Power Input	kW	123	159	189	233	254	285	319	379	464	
Cooling Rated Current	A	219	288	341	419	479	507	578	690	840	
Max.Starter Current	A	615	845	845	965	1102	1264	1358	1358	1486	
Max.Running Current	A	419	513	523	521	900	932	1026	1026	1042	
Power Supply		380-415V 3N~ 50Hz									
Evaporator	Type	Tube-and-shell evaporator									
	Flow Rate	m ³ /h	66	87	103	126	139	156	172	208	245
	Inlet/Outlet DN	DN	125	125	125	150	150	150	150	200	200
	Pressure Drop	kPa	40	53	56	57	68	72	73	70	68
	Max.Pressure	MPa	1.0								
Compressor	Type	Semi-hermetical screw compressor									
	Energy Adjusting	25%-100% four step control				12.5%-100% eight step control					
	Starter Mode	Y- Δ									
Fan	Air Flow Rate	m ³ /h	150000	200000	250000	250000	350000	350000	400000	400000	500000
	Quantity	Piece	6	8	10	10	14	14	16	16	20
Refrigerant	Type	R134a									
	System Quantity	1				2					
Dimension	Length	mm	3787	4792	5797	5797	8707	8707	9712	9712	11700
	Width	mm	2250								
	Height	mm	2420				2480				
Hydraulic Module (Option)	Built-in Hydraulic Module (Option)	Water pump, expansion tank, filter, safety valve, pressure gauge, butterfly valve etc.									
	Water Pump Type	Centrifugal single pump or twin pump (option)									
Net Weight	kg	4350	4690	5500	6050	7850	7980	9200	9550	11800	
Running Weight	kg	4550	4910	5750	6340	8190	8340	9590	9980	12400	

Note:

- Nominal cooling conditions: Chilled water inlet/outlet temperature 12/7 °C , Ambient temperature 35°C;
- Power supply fluctuation range: ± 10%.
- If you need low ambient temperature cooling function, please contact with sales representatives.
- When choose built-in hydraulic kit, please remark pump lifting.
- Due to possible product improvement, KTA reserves the right to make changes in design and construction at any time without notice.
- For more details, please contact with KTA headquarter.



TASD 345.2 AC1

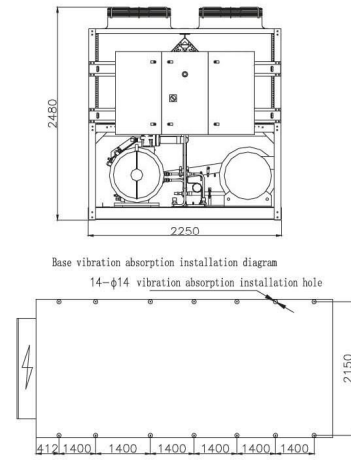
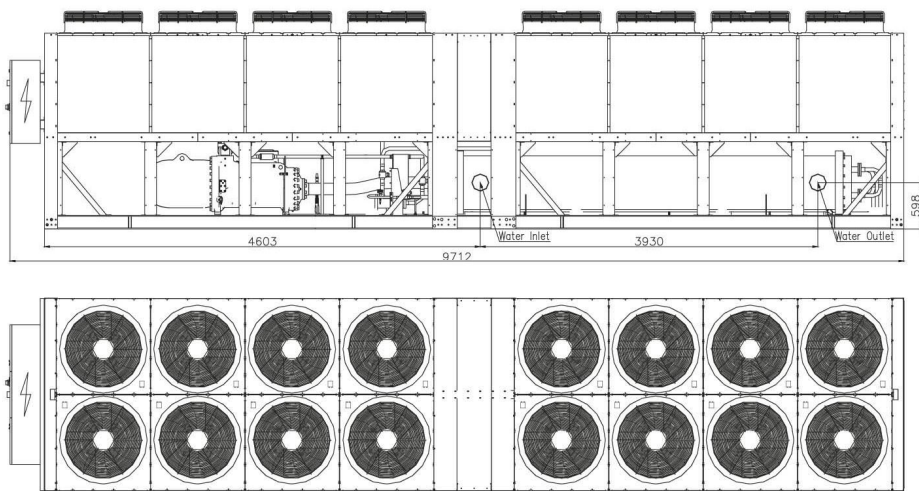

TASD 405.2 AC1

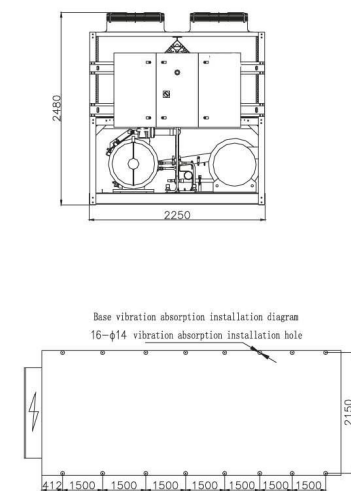
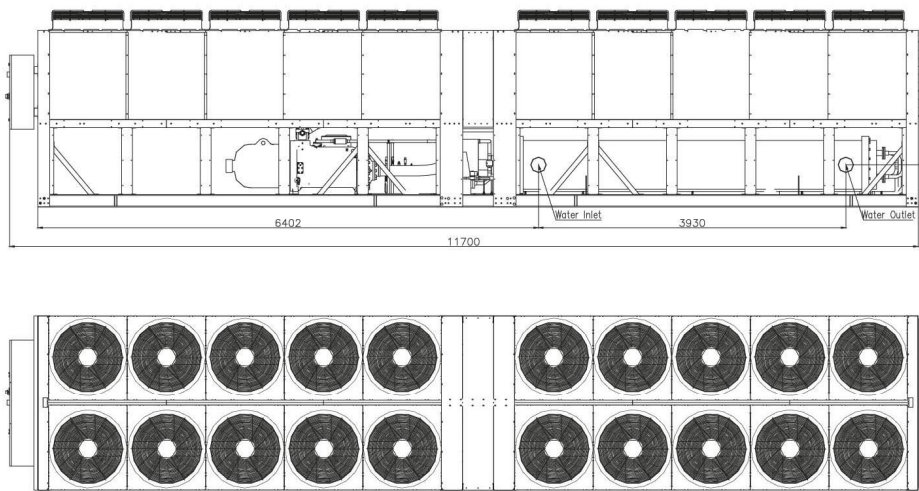

INSTALLATION SKETCH

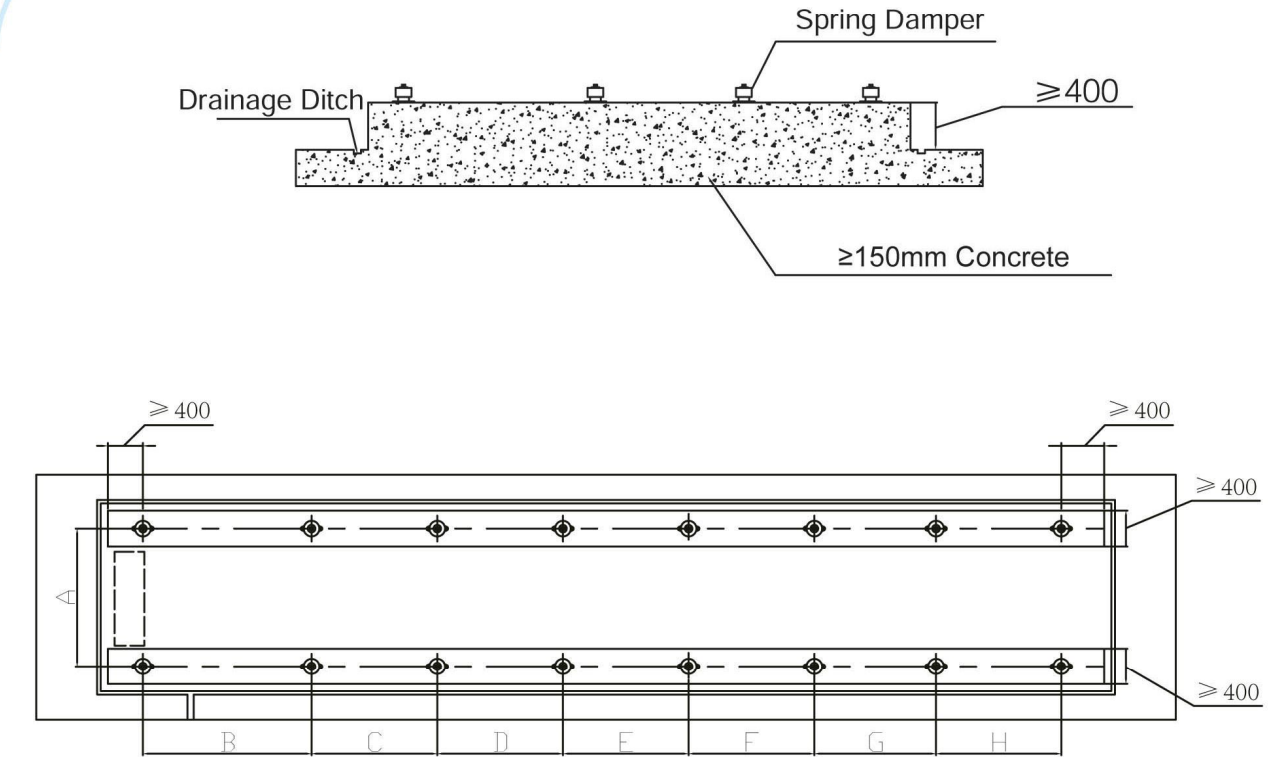

Model	Item (mm)								Spring Isolator Qty.
	A	B	C	D	E	F	G	H	
TASD110.1AC1	2170	1300	1300	-	-	-	-	-	6
TASD145.1AC1	2170	1200	1200	1200	-	-	-	-	8
TASD170.1AC1	2170	1535	1535	1535	-	-	-	-	8
TASD210.1AC1	2170	1535	1535	1535	-	-	-	-	8
TASD230.2AC1	2150	1575	1575	1575	1575	1575	-	-	12
TASD260.2AC1	2150	1575	1575	1575	1575	1575	-	-	12
TASD285.2AC1	2150	1480	1480	1480	1480	1480	1480	-	14
TASD345.2AC1	2150	1400	1400	1400	1400	1400	1400	-	14
TASD405.2AC1	2150	1500	1500	1500	1500	1500	1500	1500	16

Note:

- 1.The gradient of the foundation should be less than 0.1%
- 2.The foundation should be able to support 1.5 times of unit operating weights.
- 3.Sufficient space must be available for drain barrel
- 4.Spring islator must be installed to prevent excessice vibration and noise.
- 5.Spring islator is optional parts



UNIT INSTALLATION

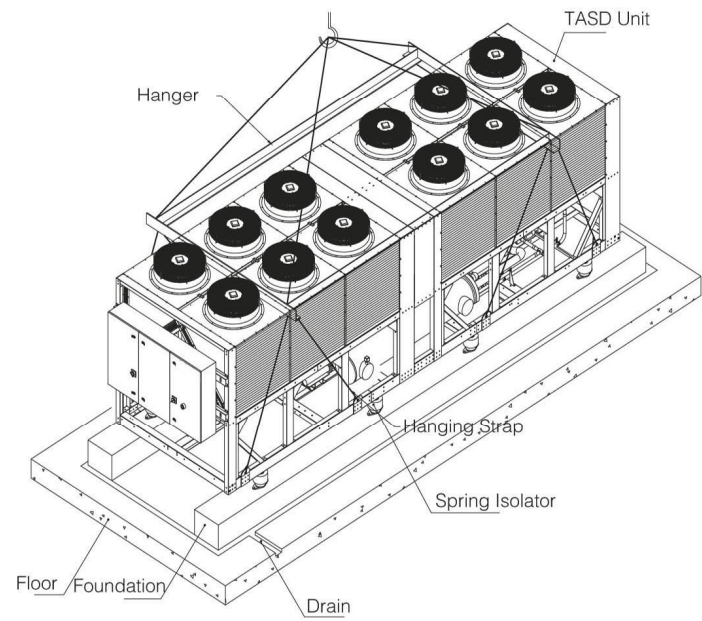

SCHEMATIC OF INSTALLATION SPACE

TASD-AC1

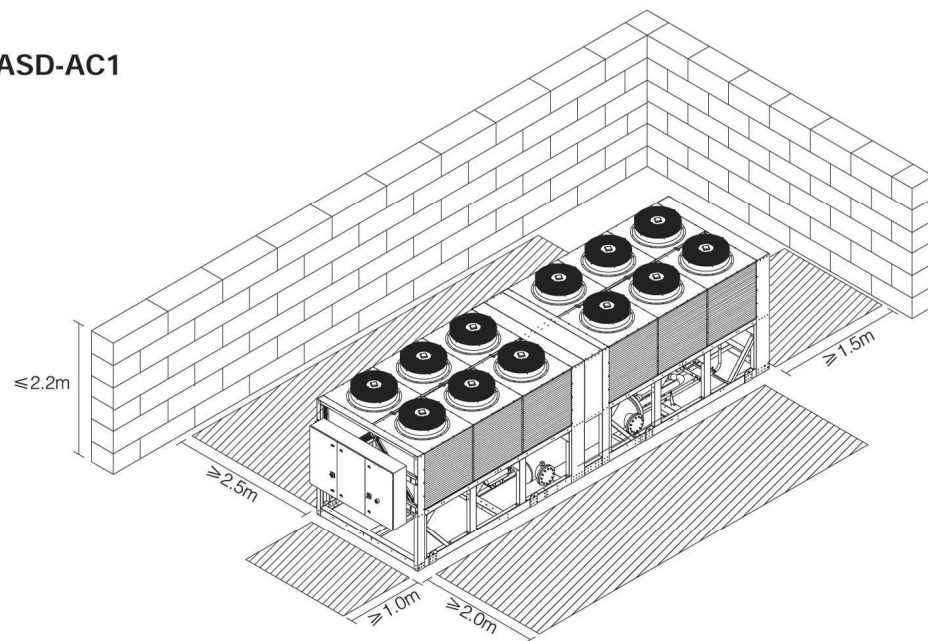

ON-SITE WIRING DIAGRAM

TASD110/145/170/210.1AC1

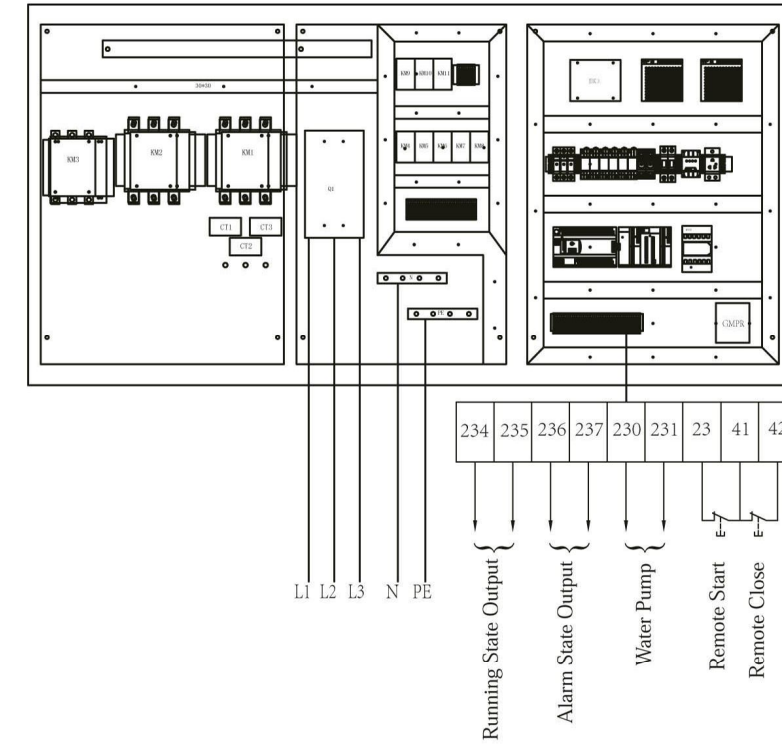

TASD230/260/285/345/405.2AC1

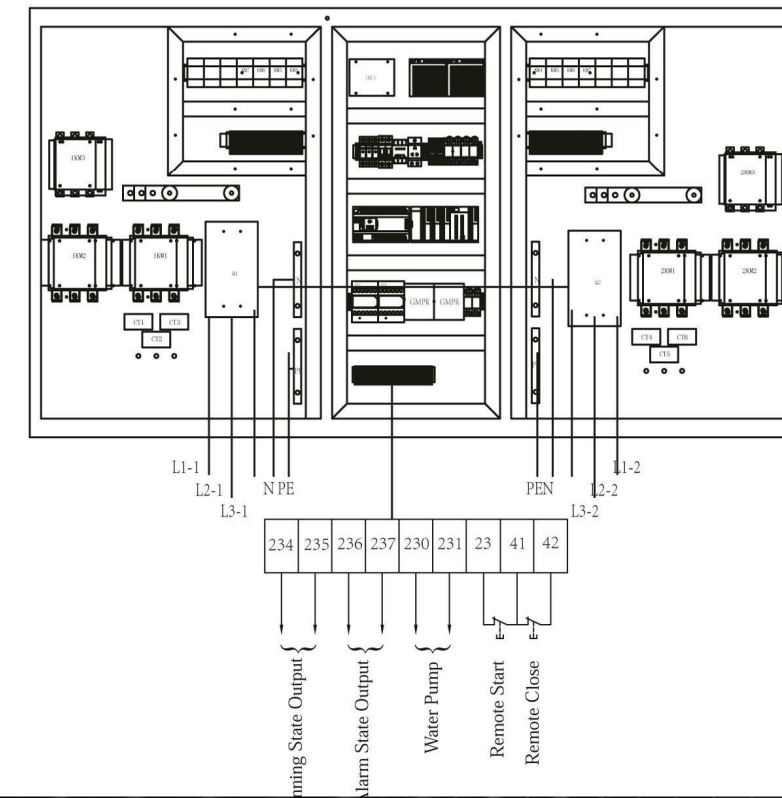

INSTALLATION AND COMMISSIONING

The chiller must be installed and maintained by professionals who have been trained, are familiar with local standards and rules and have practical operating experiences and qualifications for refrigeration equipment. Initial operation of the chiller must be carried out by professional service sectors, otherwise, quality of the chiller cannot be guaranteed.

Handling of the chiller

The chiller is loaded and transported integrally. The chiller is filled with refrigerant required for normal operation, so special care should be given during loading and transportation to avoid damage to the chiller or leakage of refrigerant due to reckless operations.

Acceptance upon arrival of goods

After arrival of the equipment, carefully check whether all items are complete or not according to the packing list, and whether components and parts are damaged during transportation or not, if damaged, please notify carriers and propose claim for compensation in written form. For any damage after the equipment is qualified by acceptance, our company does not assume any liability for damage.

Hoisting of the chiller

When the chiller is hoisted, the lifting holes on the pedestal of the chiller must be tied fast by mooring ropes or chains with enough bearing capacity to hoist. Hoisting must be operated in accordance with the requirements on hoisting schematic, and panels, fins and other parts of the chiller must be guaranteed not damaged. During hoisting dedicated lifting equipment including spreader bars and hanging brackets, etc. should be used, and inclination of the chiller is strictly forbidden to exceed 30°.

Requirements for foundation

The chiller should be placed on horizontal plane foundation, ground floor or roof that can bear operating weight of the whole equipment, for operating weight, please refer to nameplate of the chiller. For installation on the roof, damping devices such as spring damper, etc. should be equipped to avoid transmission of vibration and noise. If the position of the chiller is too high and not convenient for overhaul by servicemen, proper scaffolds can be erected around the chiller and should be able to withstand the weight of servicemen and equipment. (Some requirements on previous foundation drawing of the chiller can be referred to).

Environmental requirements

It is the best that the installation site of the chiller is in open area and enough air should pass the fin coils. Enough space should be reserved around the chiller so that air can flow into fin coils and it can be taken as overhaul channel. (Some requirements on previous schematic of installation space for the chiller can be referred to). The chiller should be used in areas at ambient temperature of over -10°C. In the areas with snow in winter and the chiller need operate in winter, if accumulated snow is possible on installation site, the installation height must be raised, it's recommended installing snow hold to guarantee normal flow of air through fin coils.

Installation of water pipes

Safety shutoff valves must be installed at inlet and outlet of the chiller with convenience for regular maintenance of water system. Installation of thermometers and pressure gages at water inlet and outlet of heat exchanger of the chiller is recommended for regular inspection and maintenance; At inlet of water pump water filter should be installed to avoid entry of impurities into water pump and heat exchanger; before thermal insulation of water pipes and entry of water into the chiller, pipeline sealing should be checked; damping devices should be installed for all pipelines connected with the chiller; flow control devices in compliance with the requirements must be installed; Installation and blowdown of water system in air conditioning project should keep away from inlet and outlet water pipelines of heat exchanger of the chiller, otherwise normal use of the chiller will be affected.

REQUIREMENTS FOR WATER QUALITY

Since compositions of water quality in different areas are complicated, if the water different from ordinary water is applied, water quality should be inspected before the water enters heat exchanger of the chiller. If water quality is under the requirement for air conditioning water, it should be treated. Relevant water treatment can refer to standard "Design Specification for Treatment of Industrial Circulating Cooling Water" or other related standards. The table below can be used as reference index.

Items	Unit	Requirement for air conditioning water
		Permissive values
Suspended solids	mg/L	<10
pH value (25°C)	mg/L	6.5-8.0
Electric conductivity (25°C)	μ S/L	<800
Methyl orange alkalinity	mg/L	<150
Acid consumption (PH=4.8)	mg/L	<100
Full hardness CaCO ₃	mg/L	<200
Fe ²⁺	mg/L	<1.0
Cl ⁻	mg/L	<200
SO ₄ ²⁻	mg/L	<200
SiO ₂	mg/L	<50
NH ₄ ⁺	mg/L	<1.0
S ²⁻	mg/L	Not detectable
Free chlorine	mg/L	<1.0
Petroleum	mg/L	<5



SCHEMATIC OF EXTERNAL WATER PIPE

Single machine

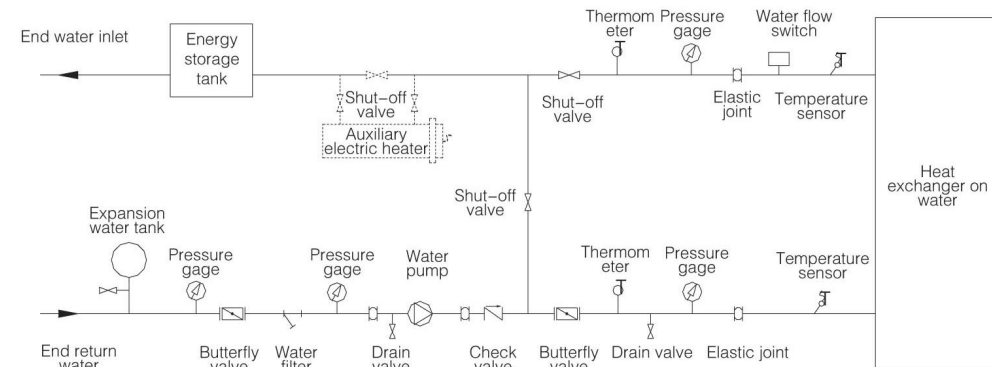

Multi-machine connected in parallel

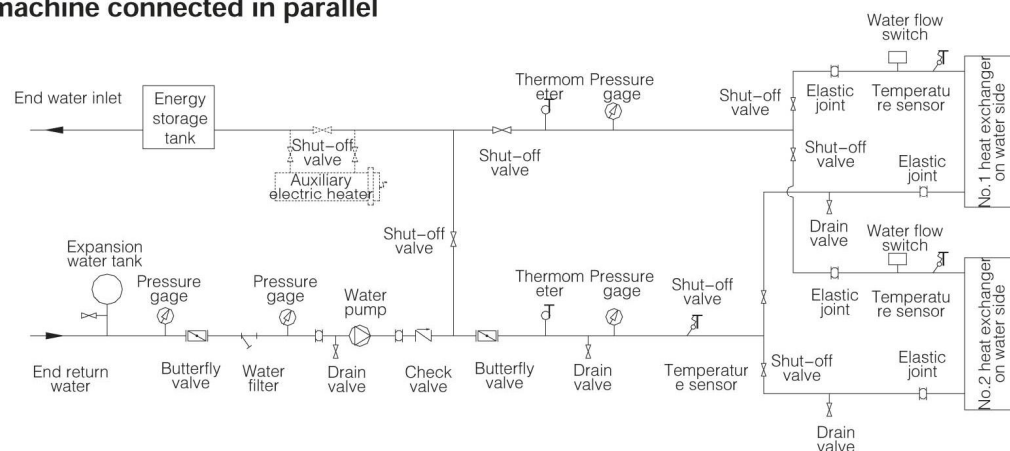

SELECTION OF WATER SYSTEM PARTS

1. Shut-off valve: determined based on water pipe diameter, and in general the valve diameter is selected in consistency with the diameter of pipe connected with the unit.
2. Water filter: play a role of filtering impurities in water system, and in general over 60-mesh filter is selected.
3. Check valve: installed at the outlet of water pump to prevent damage to water pump during backflow of water, the valve diameter is consistent with the diameter of pipe connected with the unit.
4. By-pass valve: installed between inlet and outlet water pipes of the unit container and opened when cleaning pipeline.
5. Thermometer: convenient for overhaul, maintenance and observation of operating conditions of the unit. In general 0-100°C is selected.
6. Water pump: its water yield is selected according to water flow parameters of the unit.
Water yield of pump=L*1.1 (L-water flow of the unit), the delivery head of water pump is calculated as per the following formula:
Delivery head of water pump=(water resistance of the unit + the most unfavorable pipe length* (2%-5%) + end water resistance of the most unfavorable path)*1.1
7. Automatic vent valve: play a role of discharging the air in water system to enable normal operation of the unit and installed at the highest point of the unit.
8. Expansion water tank: play a main role of accommodating excessive water, stabilizing water pressure of the system and replenishing water into the system. In general installed at return water pipe higher than water pipeline inside the system to enable normal operation of the unit. It's volume is calculated as per the following formula:
Volume of expansion water tank $V = (0.03-0.034)V_c$
 V_c = system water volume
9. Energy storage water tank: play a role of regulating energy to reduce frequent start/stop of compressor when system load changes, to improve operating efficiency of the system and meanwhile to extend service life of the unit.
Its volume is calculated as per the following formula:
Volume of energy storage water tank $V (m^3) = (Q/27.9n) - V_s$
Q - refrigerating capacity kW
n - number of heads
 V_s - water volume m³ in pipeline and heat exchanger inside the chilled water system

Notice

- The value of pipeline pressure test should be over 1.25 times the operating pressure, but not be less than 0.6MPa, after pressure is maintained for 5min, the pressure drop is not more than 0.02MPa, and the system is qualified if no leakage exists upon inspection.
- Hydrostatic test should not be carried out when air temperature is lower than 5°C, pressure gage for pressure test is qualified upon inspection with accuracy not less than 1.5 class, and the full-scale value is 1.5~2 times the maximum measured pressure.
- During pressure test feed water from low part of the system and exhaust air from high part. For pressure test, water should be fed slowly and uniformly, after water reaches the pressure required, stop operation of pump and check the system, and repair work should not be conducted with existence of pressure.
- After qualification by pressure test, wash water pipeline over and over (notice not to pass equipment) to be qualified until drainage does not carry impurities such as silt and scrap iron, etc. and is not turbid.

 Precautions in design and installation of pipelines:

1. During joint control of modules in combination, hot pump chiller cannot be combined with single cold chiller.
2. Design of water circulating system should be as simple as possible to avoid excessive elbows, and straight pipelines should be on the same plane as much as possible.
3. Notice the positions of water inlets and outlet of heat exchanger to avoid incorrect connection.
4. Manual or automatic vent valves should be installed on all peaks of water circulating system.
5. Expansion water tank should be made of anticorrosive and antirust materials and must be installed on the highest point of the whole pipeline system.
6. Thermometers and pressure gages should be installed at water inlet/outlet.
7. For double-head chillers, temperature sensing blind tubes should be reserved by the user on water main for installation of temperature sensor.
8. On the bottom of all local elbows, drain valves should be installed so as to evacuate water in the whole system.
9. Shut-off valves are installed on water pipeline for connection of heat exchanger of the chiller with water pipes of the user.
10. Bypass valves are installed between inlet and outlet water pipelines of heat exchanger of the chiller with convenience for overhaul and flush of pipelines.
11. Install elastic joints to reduce vibration of pipelines.
12. Impurities in water system will cause scaling of heat exchanger, so filter should be installed before water pump.
13. In order to improve refrigerating (heating) effect and save energy, pipelines should be strictly kept warm.
14. In order to prevent frequent tripping of the chiller due to too small load during operation, the user is recommended installing energy storage tank



UNITS OPERATION CONDITION RANGE

TASD-AC1

Cooling

Shell and Tube Heat Exchanger(Evaporator)		Minmum Temperature	Maximum Temperature
Inlet Water Temperature(Starting)		—	35
Outlet Water Temperature(Operating)		5	15
Fin Heat Exchanger (Condenser)		Minmum Temperature	Maximum Temperature
Inlet Air Temperature	R134a	15	43

Note:

If the actual application condition is beyond the above data, please contact with KTA

UNIT WATER PRESSURE DROP DIAGRAM

Air-Cooled Screw Water Side Exchanger Water Pressure Drop Diagram

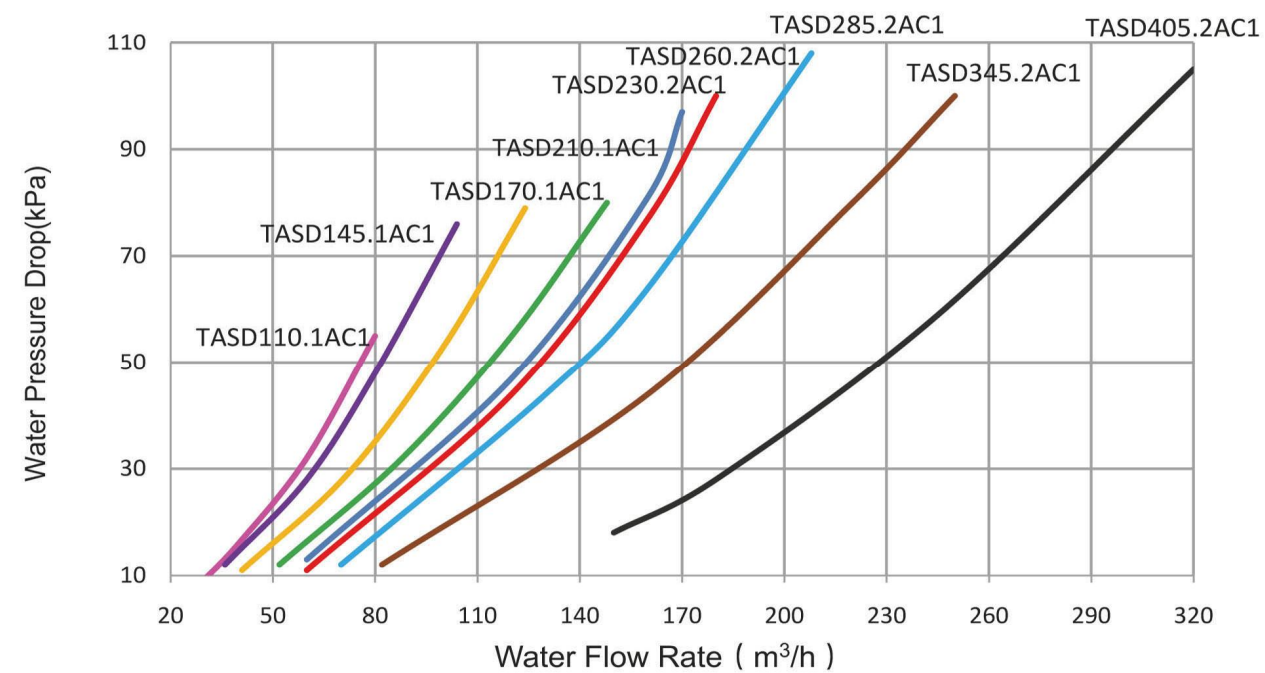

UNIT DIMENSION

TASD110.1AC1

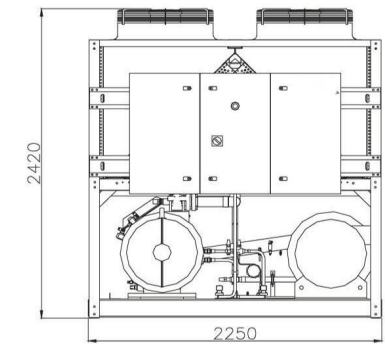
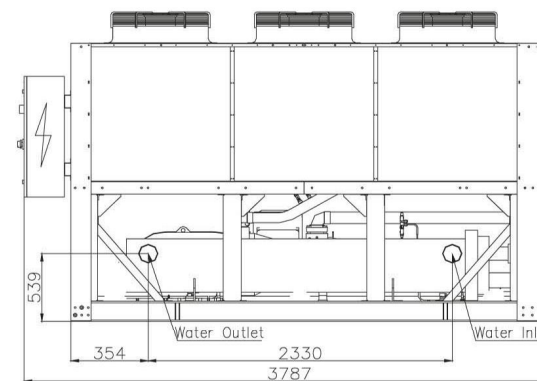

Base vibration absorption installation diagram
6-φ14 vibration absorption installation hole

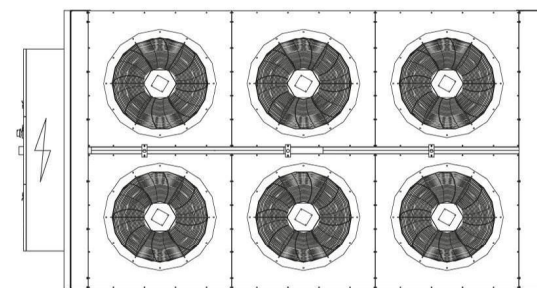
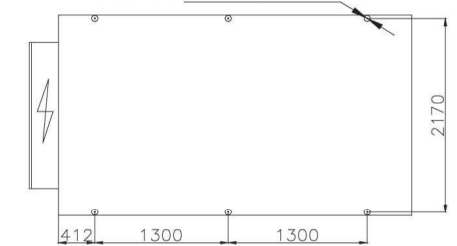

TASD145.1AC1

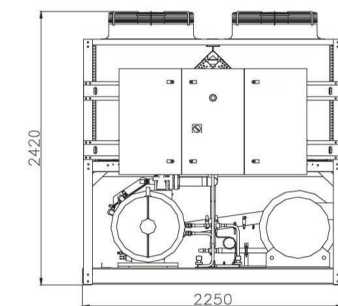
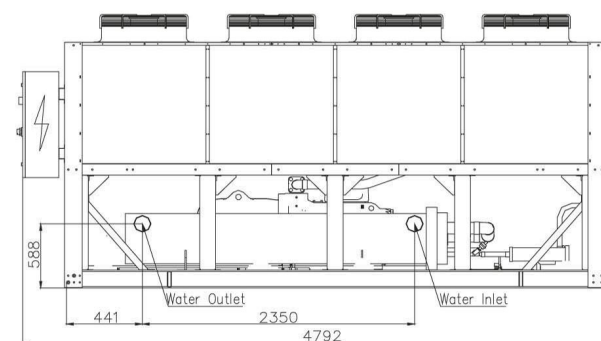

Base vibration absorption installation diagram
8-φ14 vibration absorption installation hole

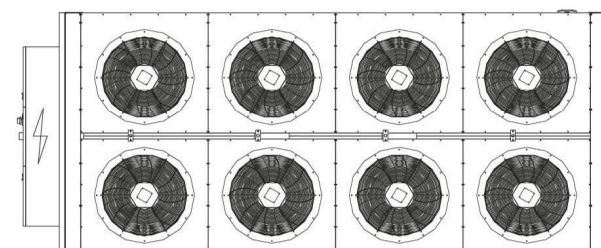
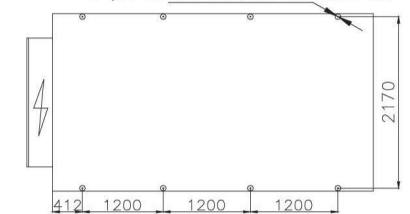

TASD170.1AC1

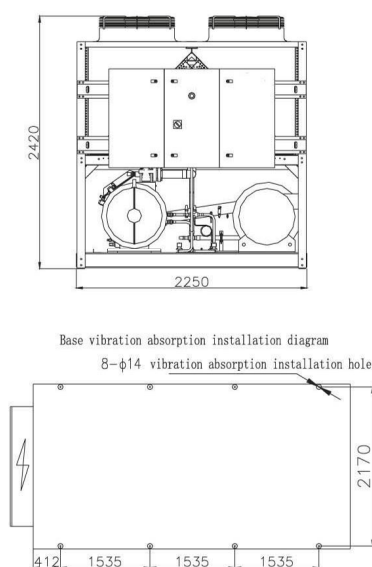
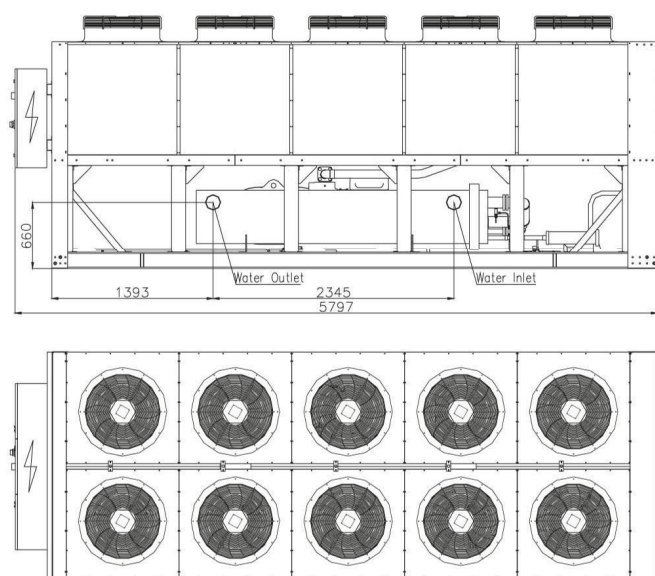

TASD 230/260.2 AC1

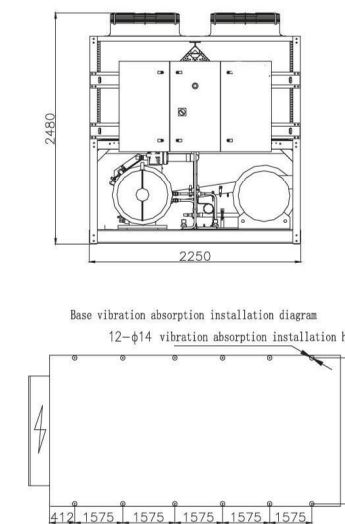
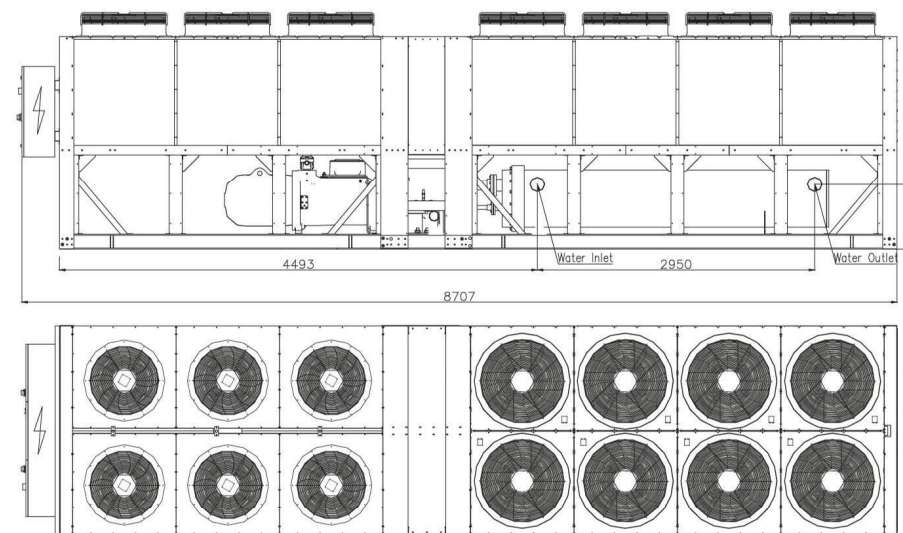

TASD210.1AC1

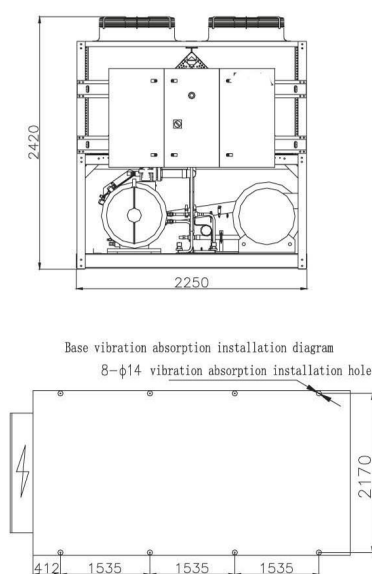
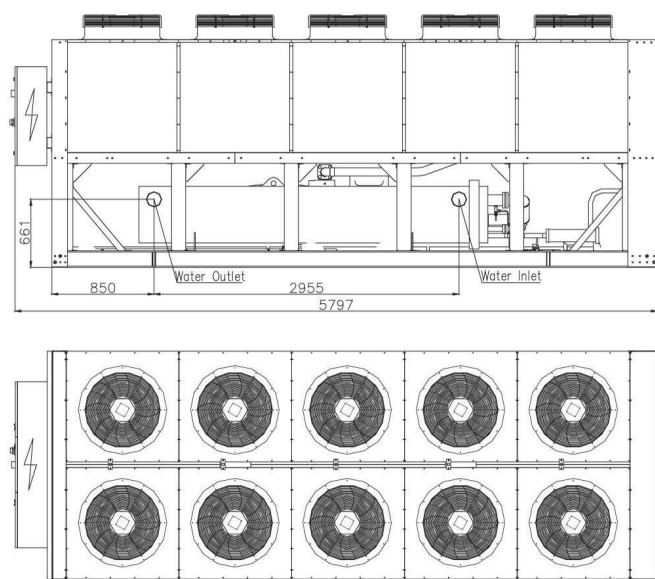

TASD 285.2 AC1

